



Table with top in glued solid wood lists, with straight sides, combined with a basic and linear base made of intertwined tubular iron, empty inside. Upon request available in intertwined full tubular iron.

STANDARD VERSION: EMPTY INTERTWINED IRON TUBULAR BASE (WEIGHT 20 KG) LACQUERED IRONDUST COLOUR (B2)

CODE	SIZE	A1	A2	A3	A4	A5
IRON LIGHT SQ 4	W.200 x D.100 x H.75,5	■	■	■	■	■
IRON LIGHT SQ 5	W.220 x D.100 x H.75,5	■	■	■	■	■
IRON LIGHT SQ 6	W.240 x D.100 x H.75,5	■	■	■	■	■
IRON LIGHT SQ 7	W.260 x D.100 x H.75,5	■	■	■	■	■
IRON LIGHT SQ 8	W.280 x D.100 x H.75,5	■	■	■	■	■
IRON LIGHT SQ 9	W.300 x D.100 x H.75,5	■	■	■	■	■

AVAILABLE FINISHES:

- A1:** walnut without knots, walnut with knots, elm
- A2:** oak without knots, oak with knots, cherry, maple
- A3:** oak without knots finish: whitened, mystic black, vintage, neutro
oak with knots finish: whitened, mystic black, vintage, neutro
- A4:** oak without knots pigmented: ash grey, white milk, total black
oak with knots pigmented: ash grey, white milk, total black
- A5:** oak: flamed london, with knots vulcano, with knots tabacco

FEASIBILITY LACQUERED IRON BASE	
B2	■
B3	■

AVAILABLE FINISHES:

- B2:** lacquered iron: iron dust, RAL (only selected colours)
- B3:** lacquered iron matt brushed effect: aged copper, aged bronze, stainless steel, titanium
lacquered iron oxidised effect

FEASIBILITY BASE IN INTERTWINED FULL TUBULAR IRON	
B2	■
B3	■

AVAILABLE FINISHES:

- B2:** lacquered iron: iron dust, RAL (only selected colours)
- B3:** lacquered iron matt brushed effect: aged copper, aged bronze, stainless steel, titanium
lacquered iron oxidised effect

IRON LIGHT SQUARED

DETAIL: TOP WITH SQUARED SIDES

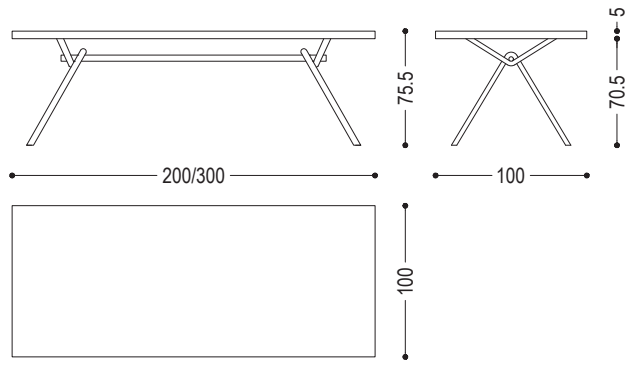

IRON LIGHT SQUARED | AVAILABLE FINISHES

WOOD

A1



walnut without knots



walnut with knots



elm

A2



oak without knots



oak with knots



cherry



maple

A3



oak without knots finish:
whitened



oak without knots finish:
mystic black



oak without knots finish:
vintage



oak without knots finish:
neutro



oak with knots finish:
whitened



oak with knots finish:
mystic black



oak with knots finish:
vintage



oak with knots finish:
neutro

A4



oak without knots pigmented:
ash grey



oak without knots pigmented:
white milk



oak without knots pigmented:
total black



oak with knots pigmented:
ash grey



oak with knots pigmented:
white milk



oak with knots pigmented:
total black

A5



oak:
flamed london













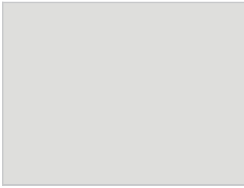

oak:
with knots vulcano

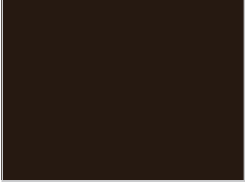
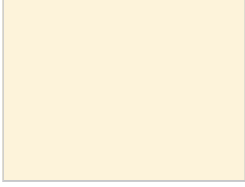
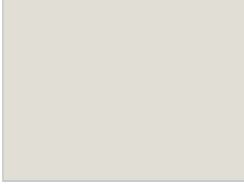

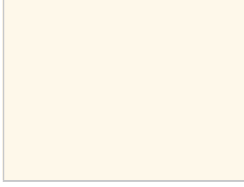
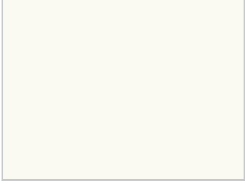
oak:
with knots tabacco

IRON LIGHT SQUARED | AVAILABLE FINISHES

IRON

B2					
	lacquered iron: iron dust	ferro laccato: RAL - 1013_OYSTER WHITE	ferro laccato: RAL - 3020_TRAFFIC RED	ferro laccato: RAL - 7035_LIGHT GREY	ferro laccato: RAL - 7037_DUSTY GREY
					
	ferro laccato: RAL - 8019_GREY BROWN	ferro laccato: RAL - 9001_CREAM WHITE	ferro laccato: RAL - 9002_GREY WHITE	ferro laccato: RAL - 9005_JET BLACK	ferro laccato: RAL - 9010_PURE WHITE
					
	ferro laccato: RAL - 9016_TRAFFIC WHITE				
B3					
	lacquered iron, matt brushed effect: aged copper	lacquered iron, matt brushed effect: aged bronze	lacquered iron, matt brushed effect: stainless steel	lacquered iron, matt brushed effect: titanium	lacquered iron, oxidised effect