

# MARIOLINA

by e-ggs



Mariolina è nata esplorando il mondo del polipropilene e i suoi nuovi sviluppi, abbinandosi delicatamente ad una estetica essenziale. La scocca è così semplice che puoi disegnarla senza staccare la penna dal foglio, bilanciando uno stile curato e attento al presente con la volontà di uscire dalle mode. Mariolina è la risposta alla necessità di un prodotto eclettico, realizzato con un metodo produttivo contemporaneo e adatto alla vita di tutti i giorni.

Mariolina came from an exploration into the world of polypropylene and its new developments, combining it with a delicate, honest aesthetic. The body is so simple that it can be drawn without the pen leaving the paper, balancing a careful style, attentive to the present, with the desire to break free of fashion.

Mariolina is the answer to the need for an eclectic product, made with a contemporary production method and suitable for everyday life.

## DIMENSIONI | DIMENSIONS

### BASIC | BASIC

lunghezza | width: 55 cm

larghezza | depth: 54 cm

altezza | height: 79 cm

altezza del sedile | seat height: 46,7 cm

impilabilità | stackability: sì (X4) | yes (X4)

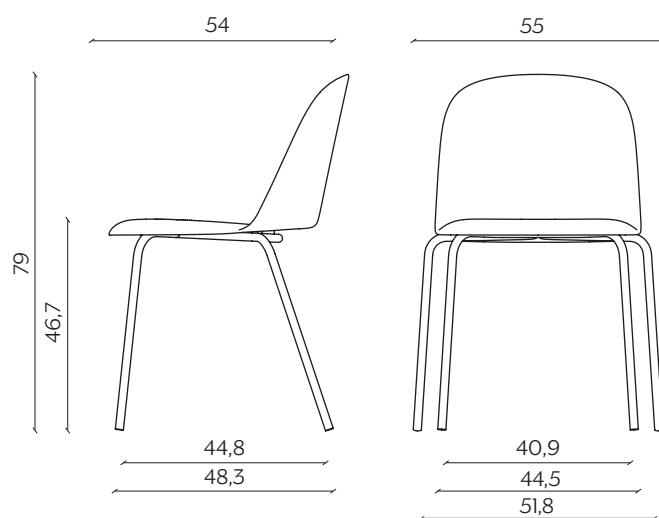

### GAMBE IN LEGNO | WOODEN LEGS

lunghezza | width: 46 cm

larghezza | depth: 54 cm

altezza | height: 79 cm

altezza del sedile | seat height: 46,7 cm

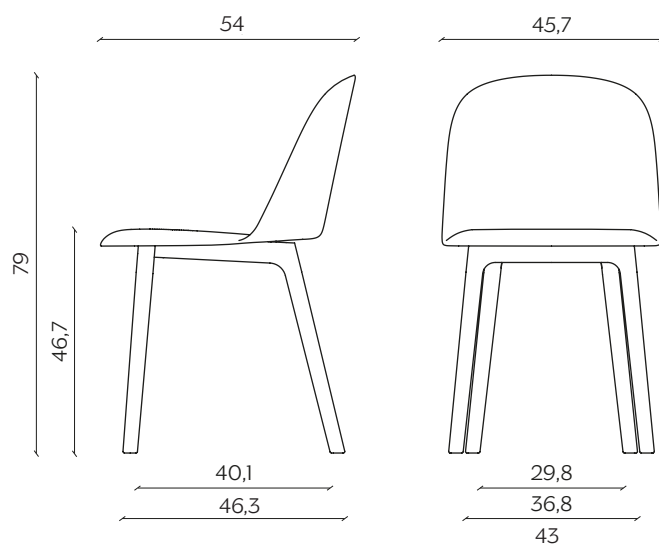

## AMBIENTE | ENVIRONMENT

interno, esterno (solo su base laccata e senza cuscino sedile)

indoor, outdoor (only on lacquered base and without seat cushion)

### SLITTA | SLED BASE

lunghezza | width: 54 cm

larghezza | depth: 53 cm

altezza | height: 79

altezza del sedile | seat height: 46,2 cm

impilabilità | stackability: sì (X4) | yes (X4)

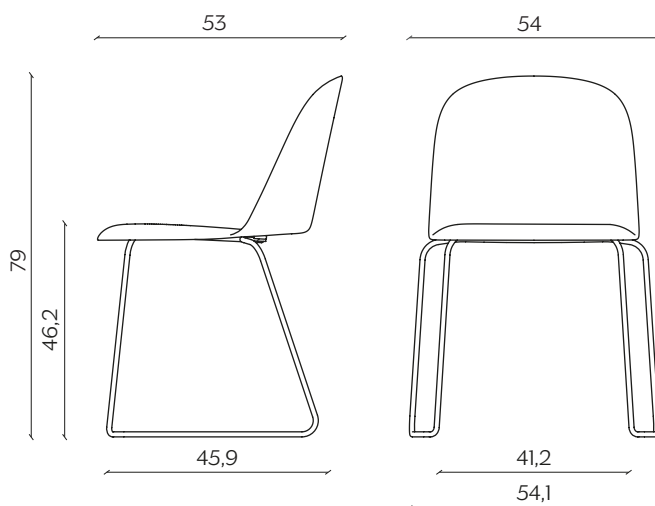

### UFFICIO | OFFICE

lunghezza | width: 45,6 cm

larghezza | depth: 53 cm

altezza | height: 78,5

altezza del sedile | seat height: 46,2

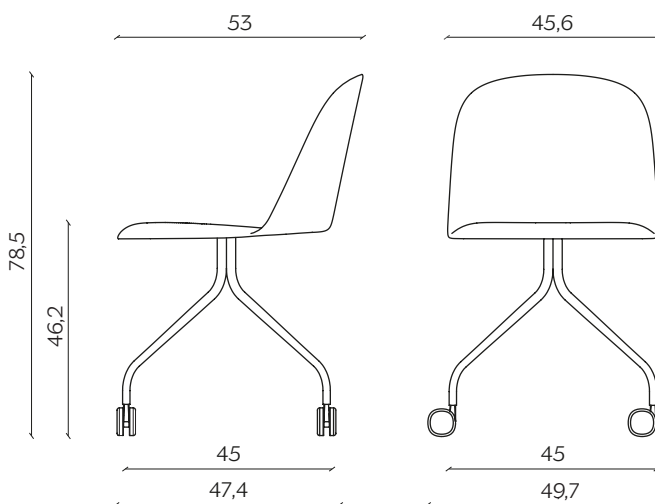

### DOWNLOAD | DOWNLOADS

la guida Cura e Manutenzione è disponibile su [miniforms.com](http://miniforms.com)  
Care and Maintenance guide is available at [miniforms.com](http://miniforms.com)

file 2D, 3D e fotografie sono disponibili su [miniforms.com](http://miniforms.com)  
2D, 3D files and hi-res images are available at [miniforms.com](http://miniforms.com)

## FINITURE | FINISHES

### GAMBE | LEGS

#### Legno | Wood



Frassino  
Ash



Frassino Nero  
Black Ash



Rame  
Copper

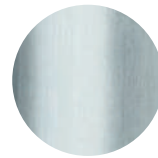

Zincato  
Zinc-coated

#### Metallo | Metal

### GAMBE E SCOCCA | LEGS AND SHELL

#### Polipropilene | Polypropilene

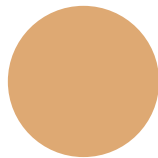

Albicocca  
Apricot

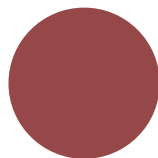

Rosso Marsala  
Marsala Red

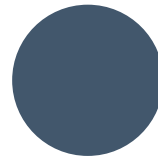

Blu Intenso  
Intense Blue



Antracite  
Anthracite

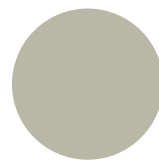

Grigio Seta  
Silk Grey

# FINITURE | FINISHES

## TESSUTI | FABRICS

A

### Salò

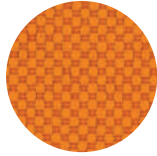

Arancio  
Orange

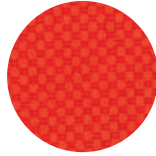

Rosso  
Red

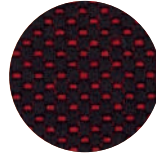

Marmellata  
Jam



Grigio Chiaro  
Light Grey



Marrone  
Brown

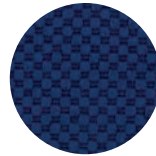

Blu Notte  
Midnight Blue

### Loop

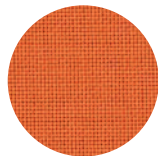

Arancione  
Orange

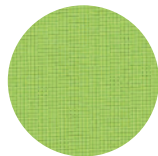

Lime

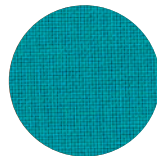

Turchese  
Turquoise

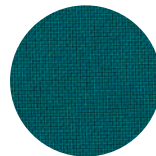

Ottanio  
Teal Green

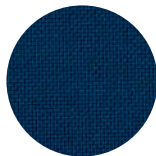

Blu Scuro  
Dark Blue



Testa di Moro  
Dark Brown

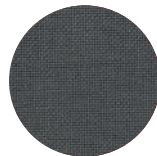

Grigio Fumo  
Smoke Grey



Nero  
Black

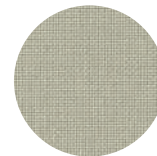

Avorio  
Ivory

# TESSUTI | FABRICS

A

## Tramè



Beije

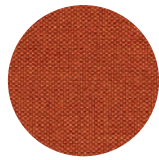

Arancio  
Orange

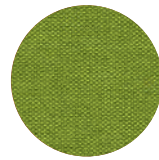

Mela  
Apple

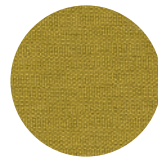

Senape  
Mustard

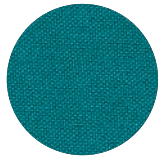

Pavone  
Peacock

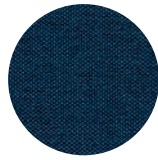

Blu Elettrico  
Electric Blue



Nero  
Black

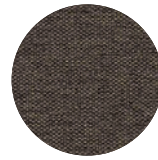

Crigio Scuro  
Dark Grey

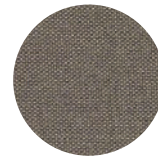

Tortora  
Dove Grey

## Madrid

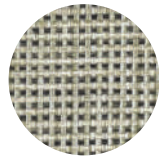

Burro  
Butter

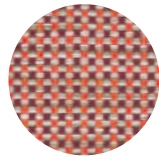

Melograno  
Pomegranate

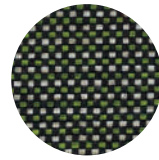

Menta  
Mint

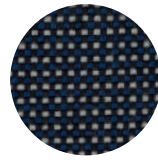

Notte  
Night

# FINITURE | FINISHES

## TESSUTI | FABRICS

B

### Kvadrat Relate

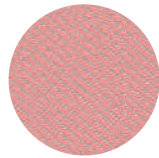

Rosa  
Pink

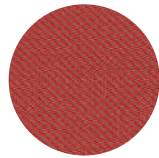

Rosso  
Red

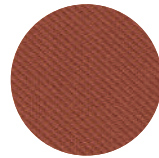

Terra  
Ground

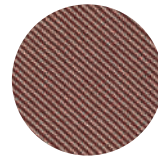

Snack

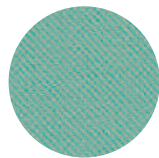

Menta  
Mint

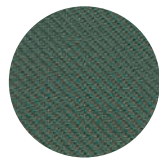

Verde Bosco  
Forest Green

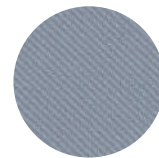

Nuvolo  
Cloudy

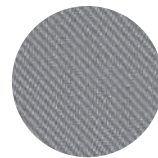

Grigio  
Grey

### Lanee



Grigio  
Grey

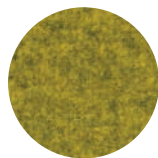

Giallo  
Yellow

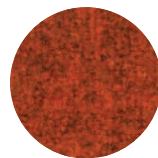

Rosso  
Red

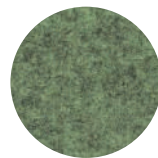

Menta  
Mint

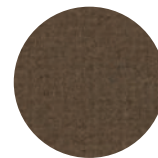

Marrone  
Brown

## TESSUTI | FABRICS

B

### Torrilana Cubbio

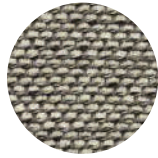

Sale e Pepe  
Salt and Pepper

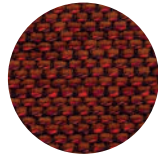

Ambra  
Amber

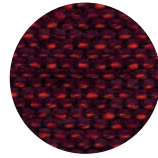

Bordeaux

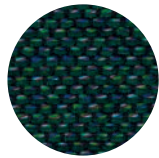

Verde Petrolio  
Petrol Green

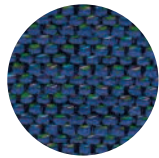

Blu Elettrico  
Electric Blue



Castagna  
Walnut

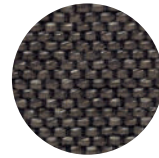

Tortora  
Dove Grey

### Mesh

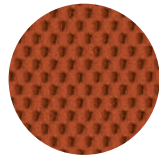

Rosso Corallo  
Coral Red

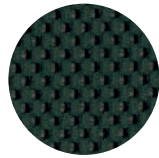

Verde Salvia  
Sage Green

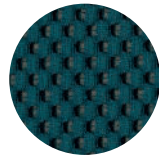

Foglia di Tè  
Teal

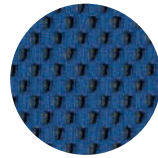

Blu Neon  
Neon Blue



# TESSUTI | FABRICS

B

## Vescom Wilson

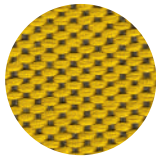

Ciallo Elettrico  
Electric Yellow

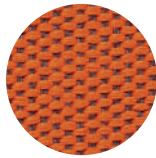

Energico  
Energetic

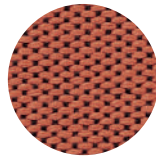

Rosé

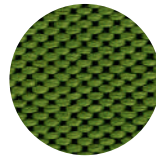

Laguna  
Lagoon

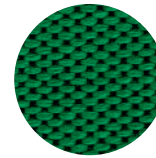

Prato  
Field

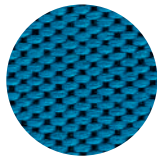

Zaffiro  
Sapphire

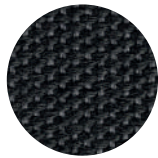

Grafite  
Graphite

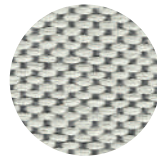

Sale e Pepe  
Salt and Pepper

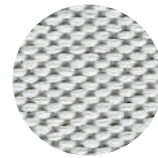

Neve  
Snow

## Vescom Norfolk

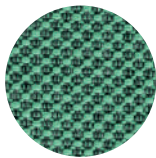

Latte e Menta  
Milk and Mint

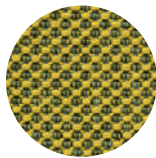

Ape  
Bee

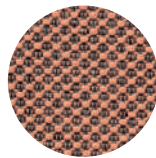

Rosa  
Pink

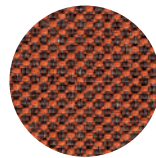

Mattone  
Brick

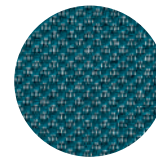

Petrolio  
Petrol-Green

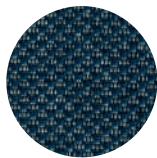

Notte  
Night

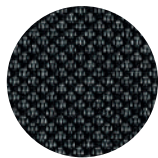

Antracite  
Anthracite

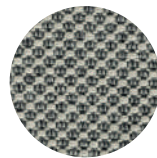

Sale e Pepe  
Salt and Pepper

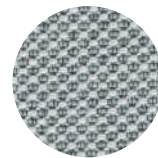

Ghiaccio  
Ice

# FINITURE | FINISHES

## TESSUTI | FABRICS

C

### Shelter Velvet



Crema  
Cream



Rosa Intenso  
Intense Rose



Terra di Siena  
Burnt Sienna



Cammello  
Camel



Verde  
Green

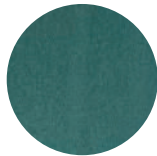

Turchese  
Turquoise



Blu Notte  
Midnight Blue



Testa di Moro  
Dark Brown

### Kvadrat Field 2

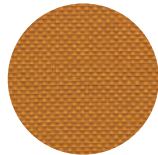

Zafferano  
Saffron-Yellow

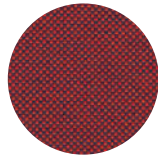

Ciliegia  
Cherry

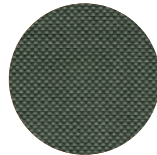

Menta  
Mint

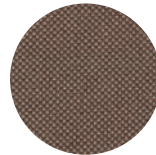

Nocciola  
Hazel

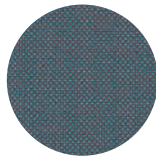

Zucchero  
Sugar

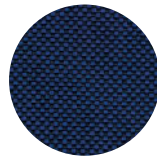

Blu  
Blue

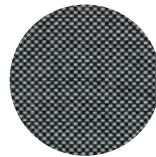

Sale e Pepe  
Salt and Pepper

### Torrilana Brionne

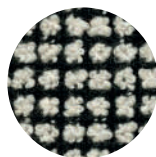

Black and White

## TESSUTI | FABRICS

C

### Vescom Harding

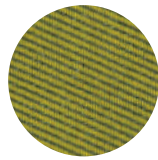

Ciallo  
Yellow

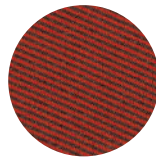

Rosso  
Red

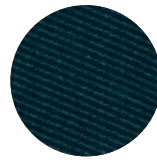

Petrolio  
Blue-Green

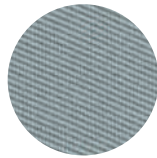

Grigio Chiaro  
Light Grey

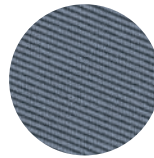

Nuvolo  
Cloudy

### Vescom Rolla

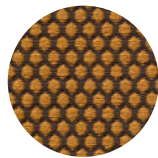

Mostarda  
Mustard

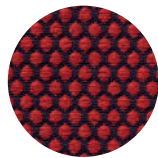

Ciliegia  
Cherry

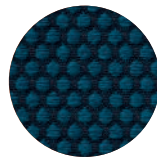

Blu Pavone  
Peacock

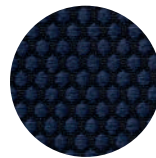

Blu Notte  
Midnight Blue

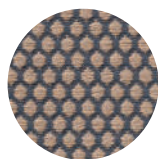

Latte  
Steamed Milk

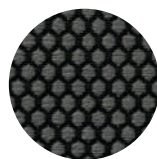

Antracite  
Anthracite

### Torrilana Rakam



Bacca  
Berry

# FINITURE | FINISHES

## TESSUTI | FABRICS

D

### Cloud



Panna  
Cream



Noce  
Walnut



Nocciola  
Hazelnut

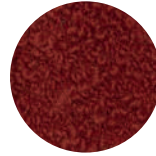

Bordeaux

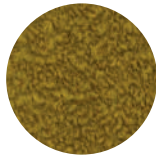

Senape  
Mustard

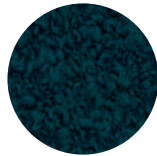

Petrolio  
Blue-Green

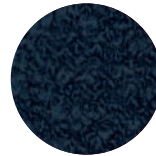

Blu Notte  
Night Blue

### Maharam Merit

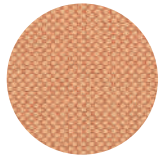

Salmone  
Salmon

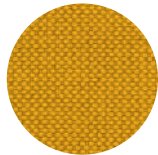

Ciallo  
Yellow

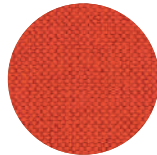

Rosso Corallo  
Coral Red



Marrone  
Brown

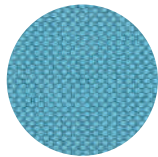

Celeste  
Sky Blue

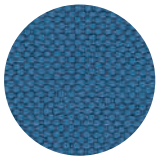

Blu Cobalto  
Cobalt Blue

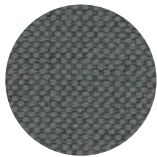

Grigio  
Grey

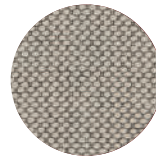

Sale e Pepe  
Salt and Pepper

TESSUTI | FABRICS

D

Rohi Sera

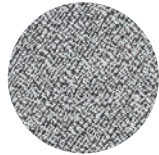

Pepper

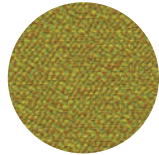

Tivoli

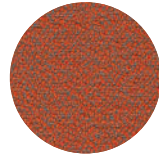

Glow

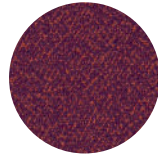

Berry

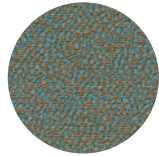

Mirage

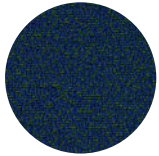

Mare

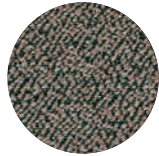

Walnut

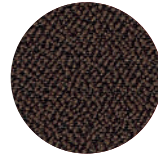

Rosewood

Rohi Mica

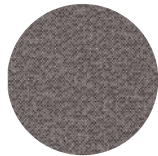

Pepper

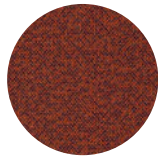

Indio

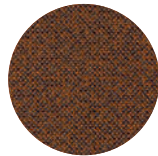

Amber

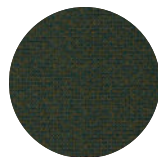

Jungle

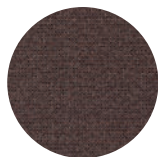

Mud

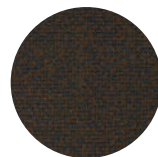

Secret

# FINITURE | FINISHES

## TESSUTI | FABRICS

E

### Kvadrat Steelcut Trio 3

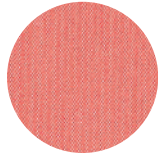

Arancia Rossa  
Red Orange

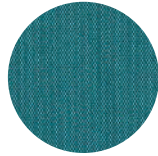

Pavone  
Peacock

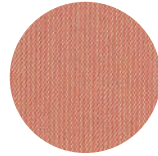

Pesca  
Peach



Sale e Pepe  
Salt and Pepper



Elettricità  
Electricity